

5.7" TFT – 320x240 dots with PCAP

SPECIFICATION

CUSTOMER : _____

MODULE NO.: EA TFT057-32CTS

<p>APPROVED BY: (FOR CUSTOMER USE ONLY)</p>	<p>PCB VERSION: DATA:</p>
--	--

SALES BY	APPROVED BY	CHECKED BY	PREPARED BY
<p>ISSUED DATE: 2023/05/16</p>			

Content

1. Summary	3
2. General Specifications.....	3
3. Absolute Maximum Ratings.....	4
4. Electrical Characteristics	4
4.1. Operating conditions:	4
4.2. LED driving conditions	4
5. DC Characteristics.....	5
6. AC Characteristics	6
6.1. 24-bits parallel RGB Interface	6
7. Optical Characteristics.....	7
8. Interface	9
8.1. LCM Pin Definition	9
8.2. Touchpanel Pin Definition	10
9. Block Diagram	11
10. Reliability	12
11. Touchpanel Information	13
11.1 PCAP controller ILI2130.....	14
11.2 I ² C AC Characteristics.....	14
11.3 Power On Sequence	15
11.4 Power Off to On Sequence	15
11.5 Code example for PCAP	16
11.6 Programming guide for PCAP	18
11.7 Comparison between ILI2130 and FT5426 (EA TFT057-84ATS).....	18
12. Contour Drawing.....	19

1. SUMMARY

The EA TFT057-84CTS is a TN transmissive type color active matrix TFT liquid crystal display that use amorphous silicon TFT as switching devices. This module is a composed of a TFT_LCD module, It is usually designed for industrial application and this module follows RoHS.

Touchpanel controller for I²C bus ILI2130 is included.

1.1. ACCESSORIES

ZIF connector for display, bottom contact

EA WF050-40S

ZIF connector for display, top contact

EA WF050-40ST

ZIF connector for touch panel, top contact

EA WF050-10T

2. GENERAL SPECIFICATIONS

Item	Dimension	Unit
Size	5.7	inch
Dot Matrix	320 x RGB x 240 (TFT)	dots
Module dimension	141.12(W) x 101.55(H) x 7.79(D)	mm
Active area	115.2 x 86.40	mm
Dot pitch	0.12 x 0.36	mm
LCD type	TFT, Normally White, Transmissive	
TFT Driver IC	HX8218 +HX8615 or Equivalent	
TFT Interface	24-bit RGB	
View Direction	12 o'clock	
Gray Scale Inversion Direction	6 o'clock	
Aspect Ratio	4:3	
Backlight Type	LED white	
Brightness	700 cd/m ² (typ.)	
TP / Touchpanel	With PCAP	
TP IC	ILI2130	
TP Interface	I ² C	
TP Resolution	16384x16384	
Surface	Glare	

*Color tone slight changed by temperature and driving voltage

3. ABSOLUTE MAXIMUM RATINGS

Item	Symbol	Min	Typ	Max	Unit
Operating Temperature	TOP	-20	—	+70	°C
Storage Temperature	TST	-30	—	+80	°C

Note: Device is subject to be damaged permanently if stresses beyond those absolute maximum ratings listed above

- Temp. $\leq 60^{\circ}\text{C}$, 90% RH MAX. Temp. $> 60^{\circ}\text{C}$, Absolute humidity shall be less than 90% RH at 60°C

4. ELECTRICAL CHARACTERISTICS

4.1. OPERATING CONDITIONS:

Item	Symbol	Condition	Min	Typ	Max	Unit
Supply Voltage For Logic	VCC	—	3.0	3.3	3.6	V
Supply Current	ICC	VCC=3.3V	—	230	345	mA

4.2. LED DRIVING CONDITIONS

Parameter	Symbol	Min.	Typ.	Max.	Unit	Remark
LED current	—	—	140	—	mA	—
Power Consumption	—	1204	—	1470	mW	—
LED voltage	VBL+	8.6	—	10.5	V	Note 1
LED Life Time	—	—	50,000	—	Hr	Note 2,3,4

Note 1 : There are 1 Groups LED

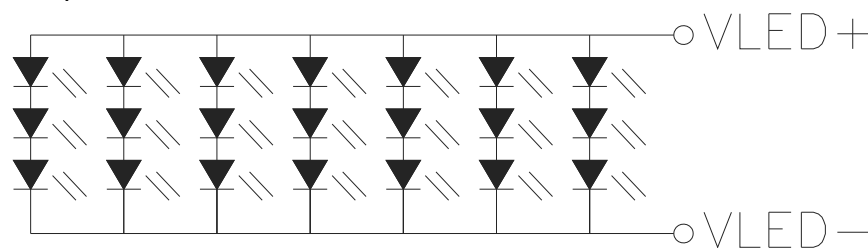

Backlight LED Circuit

Note 2 : $T_a = 25^{\circ}\text{C}$

Note 3 : Brightness to be decreased to 50% of the initial value

Note 4 : The single LED lamp case.

5. DC CHARACTERISTICS

Parameter	Symbol	Rating			Unit	Condition
		Min	Typ	Max		
Low level input voltage	V_{IL}	0	-	0.3VCC	V	
High level input voltage	V_{IH}	0.7VCC	-	VCC	V	

6. AC CHARACTERISTICS

6.1. 24-BITS PARALLEL RGB INTERFACE

AC Timing Characteristics

Signal	Item	Symbol	Min.	Typ.	Max.	Unit	
Dclk	Frequency	Dclk	-	6.4	-	MHZ	
	High time	Tch	-	78	-	ns	
	Low time	Tcl	-	78	-	ns	
Data	Setup time	Tds	12	-	-	ns	
	Hold time	Tdh	12	-	-	ns	
Hsync	Period	TH	-	408	-	DCLK	
	Pulse Width	Thp	-	30	-	DCLK	
	Back-Porch	Thb	-	38	-	DCLK	
	Display Period	Thd	-	320	-	DCLK	
	Front-Porch	Thf	-	20	-	DCLK	
Vsync	Period	NTSC	-	262.5	-	DCLK	
		PAL		312.5			
	Pulse Width		Tvp	1	3	5	TH
	Back-Porch	NTSC	-	15	-	-	TH
		PAL		23			
	Display Period		Tvd	-	240	-	TH
	Front-Porch	NTSC	-	4.5	-	-	TH
PAL		46.5					

AC Timing Diagrams

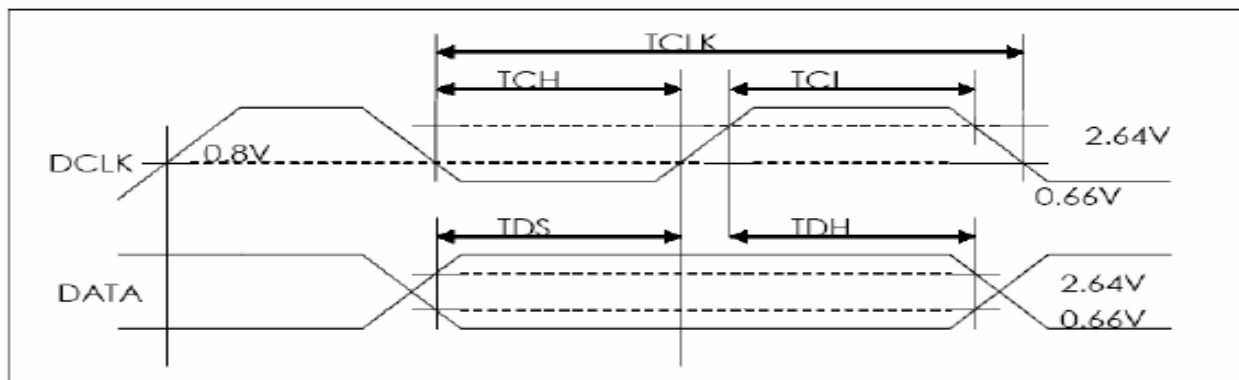
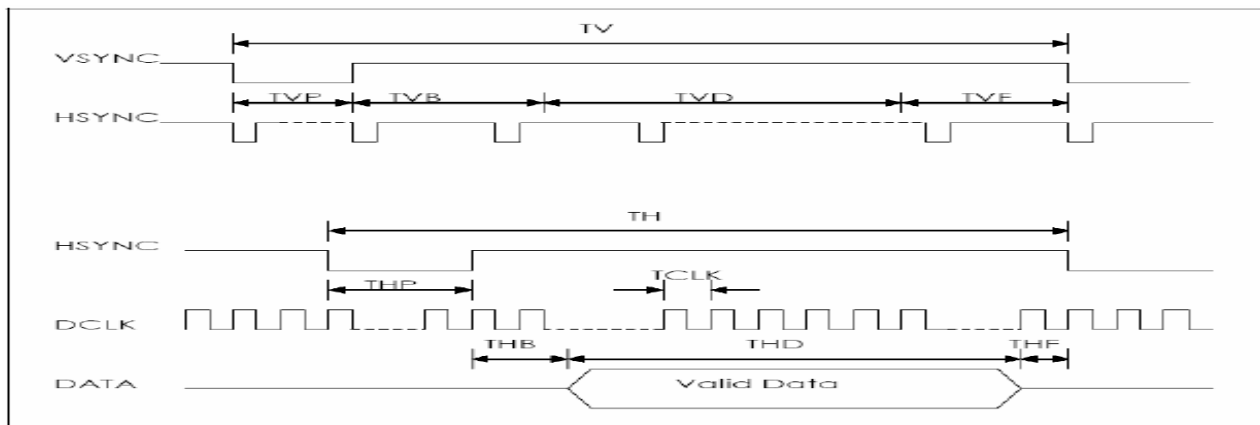

7. OPTICAL CHARACTERISTICS

Item	Symbol	Condition.	Min	Typ.	Max.	Unit	Remark	
Response time	Tr+ Tf	$\theta=0^\circ \cdot \Phi=0^\circ$	-	25	-	.ms	Note 3,5	
Contrast ratio	CR	At optimized viewing angle	-	300	-	-	Note 4,5	
Color Chromaticity	White	Wx	$\theta=0^\circ \cdot \Phi=0$	0.267	0.317	0.367	Note 2,6,7	
		Wy		0.303	0.353	0.403		
Viewing angle (Gray Scale Inversion Direction)	Hor.	Θ_R	$CR \geq 10$	-	60	-	Deg.	Note 1
		Θ_L		-	60	-		
	Ver.	Φ_T		-	70	-		
		Φ_B		-	70	-		
Brightness	-	-	600	700	-	cd/m ²	Center of display	
Uniformity	(U)	-	75	-	-	%	Note 5	

Ta=25±2°C, IL=140mA

Note 1: Definition of viewing angle range

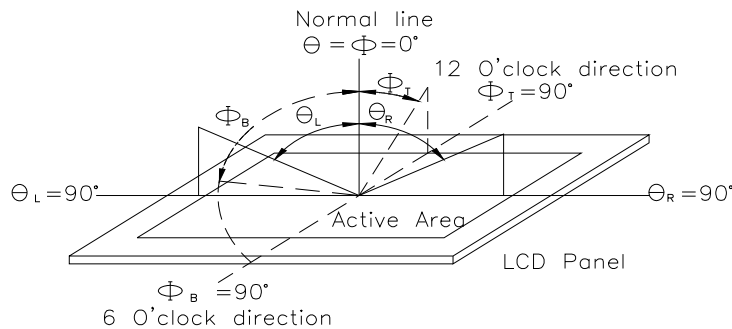

Fig.8.1. Definition of viewing angle

Note 2: Test equipment setup:

After stabilizing and leaving the panel alone at a driven temperature for 10 minutes, the measurement should be executed. Measurement should be executed in a stable, windless, and dark room. Optical specifications are measured by Topcon BM-7orBM-5 luminance meter 1.0° field of view at a distance of 50cm and normal direction.

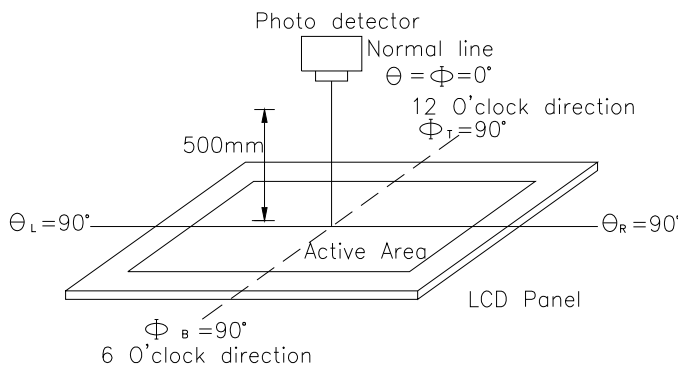
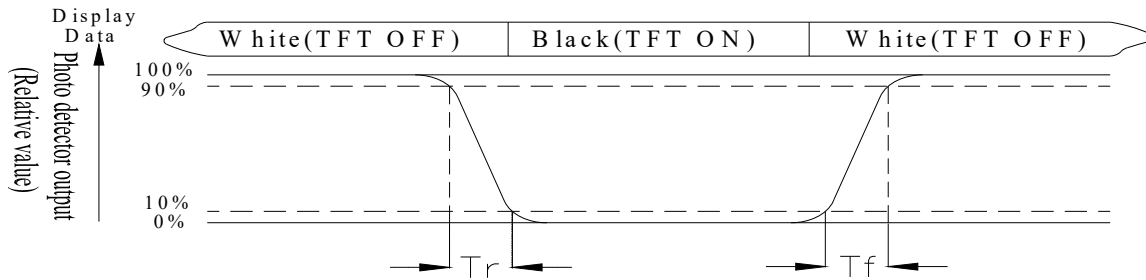

Fig. 8.2. Optical measurement system setup

Note 3: Definition of Response time:

The response time is defined as the LCD optical switching time interval between “White” state and “Black” state. Rise time, T_r , is the time between photo detector output intensity changed from 90% to 10%. And fall time, T_f , is the time between photo detector output intensity changed from 10% to 90%



Note 4: Definition of contrast ratio:

The contrast ratio is defined as the following expression.

$$\text{Contrast ratio (CR)} = \frac{\text{Luminance measured when LCD on the "White" state}}{\text{Luminance measured when LCD on the "Black" state}}$$

Note 5: Definition of Luminance Uniformity

Active area is divided into 9 measuring areas (reference the picture in below). Every measuring point is placed at the center of each measuring area.

$$\text{Luminance Uniformity (U)} = \text{Lmin/Lmax} \times 100\%$$

L = Active area length

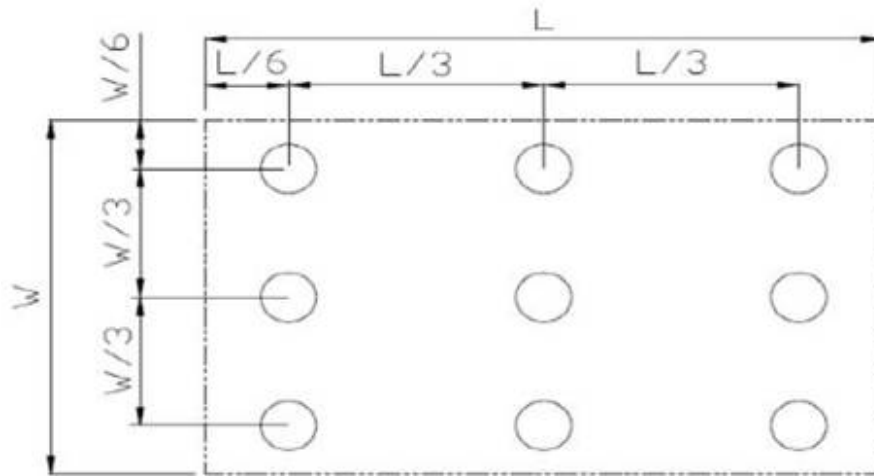

W = Active area width

Fig8.3. Definition of uniformity

Note 6: Definition of color chromaticity (CIE 1931)

Color coordinates measured at the center point of LCD

Note 7: Measured at the center area of the panel when all the input terminals of LCD panel are electrically opened.

8. INTERFACE

8.1. LCM PIN DEFINITION

Pin	Symbol	Function	Remark
1	NC	No connection	
2	NC	No connection	
3	GND	System ground pin of the IC. Connect to system ground.	
4	VCC	Power Supply	
5	R0	Red Data bit(LSB)	
6	R1	Red Data bit	
7	R2	Red Data bit	
8	R3	Red Data bit	
9	R4	Red Data bit	
10	R5	Red Data bit	
11	R6	Red Data bit	
12	R7	Red Data bit (MSB)	
13	G0	Green Data bit(LSB)	
14	G1	Green Data bit	
15	G2	Green Data bit	
16	G3	Green Data bit	
17	G4	Green Data bit	
18	G5	Green Data bit	
19	G6	Green Data bit	
20	G7	Green Data bit (MSB)	
21	B0	Blue Data bit(LSB)	
22	B1	Blue Data bit	
23	B2	Blue Data bit	
24	B3	Blue Data bit	
25	B4	Blue Data bit	
26	B5	Blue Data bit	
27	B6	Blue Data bit	
28	B7	Blue Data bit (MSB)	
29	GND	System ground pin of the IC. Connect to system ground.	
30	CLK	Dot data clock	
31	R/L	Shift direction of device internal shift register control.	Note2,3
32	HSYNC	Horizontal sync signal	Note1
33	VSYNC	Vertical sync signal	Note1
34	DE	Data Enable signal	Note1
35	U/D	Up/down selection	Note2,3
36	RESET	Hardware reset	
37-40	NC	No connection	

Note 1: SYNC mode / DE mode

For digital 24Bit RGB input data format, both SYNC mode and DE mode are supported. If DE signal is fixed low, SYNC mode is used. Otherwise, DE mode is used. Suggest used SYNC mode!!

Mode	D[23:16]	D[15:8]	D[7:0]	IHS	IVS	DEN
24 bit RGB	R[7:0]	G[7:0]	B[7:0]	HSYNC	VSYNC	DE signal is fixed low for SYNC mode
				Floating if not used	Floating if not used	DE for DE Mode

Note 2: Selection of scanning mode

Setting of scan control input		Scanning direction
U/D	R/L	
GND	VCC	Up to down, left to right
VCC	GND	Down to up, right to left
GND	GND	Up to down, right to left
VCC	VCC	Down to up, left to right

Note 3: Definition of scanning direction. Refer to the figure as below:

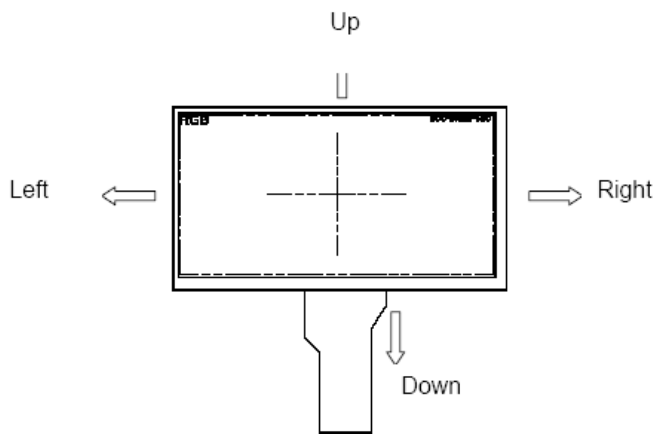

8.2. TOUCHPANEL PIN DEFINITION

Pin	Symbol	Function	Remark
1	VSS	Ground for analog circuit	
2	VDDT	Power Supply : +3.3V	
3	SCL	I2C clock input	
4	NC	No connect	
5	SDA	I2C data input and output	
6	NC	No connect	
7	/RST	External Reset, Low is active	
8	NC	No connect	
9	/INT	External interrupt to the host	
10	VSS	Ground for analog circuit	

9. BLOCK DIAGRAM

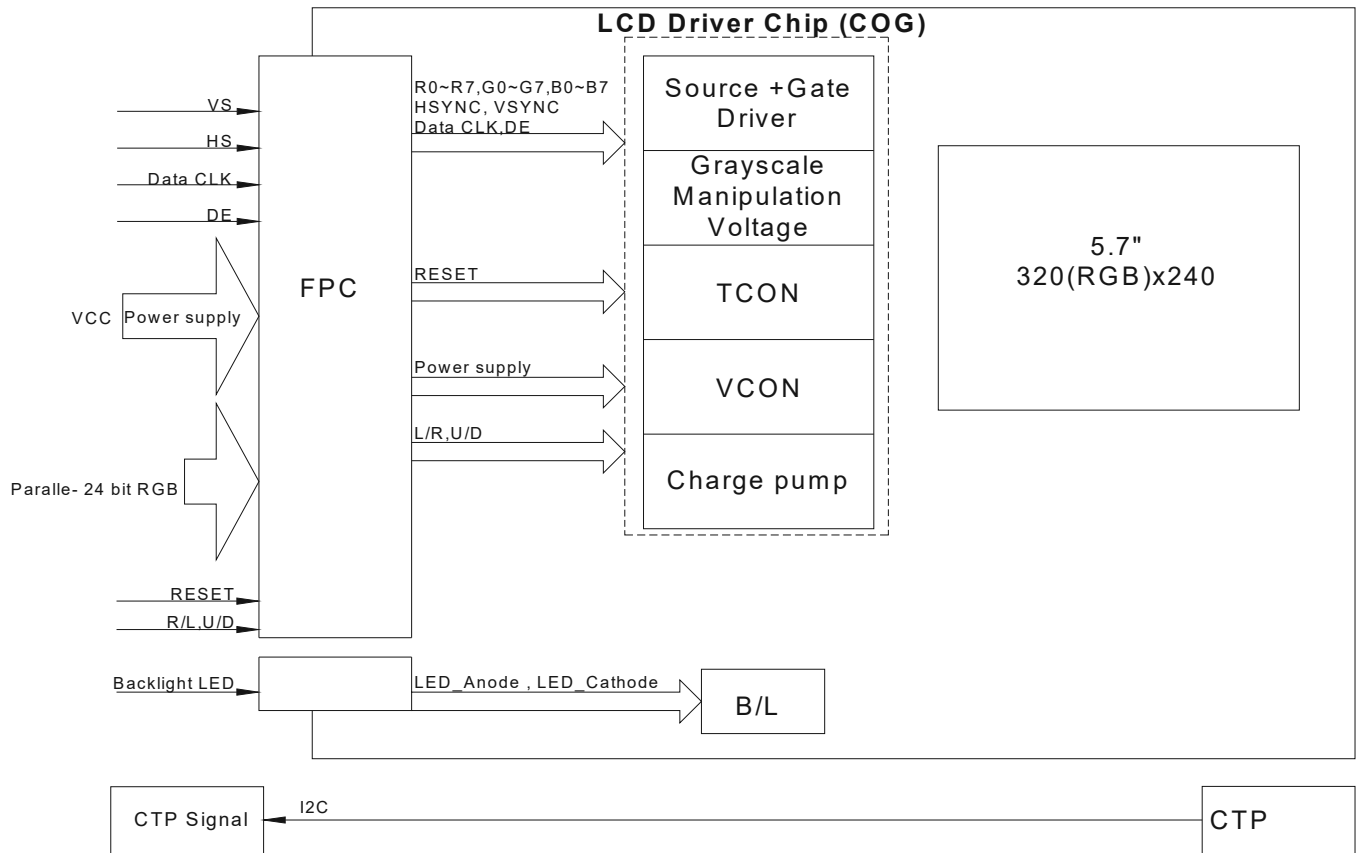

10. RELIABILITY

Content of reliability test (wide temperature, -20°C~70°C)

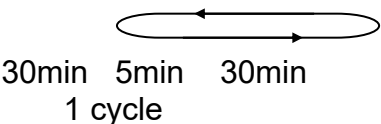
Environmental Test			
Test Item	Content of Test	Test Condition	Note
High Temperature storage	Endurance test applying the high storage temperature for a long time.	80°C 200hrs	2
Low Temperature storage	Endurance test applying the low storage temperature for a long time.	-30°C 200hrs	1,2
High Temperature Operation	Endurance test applying the electric stress (Voltage & Current) and the thermal stress to the element for a long time.	70°C 200hrs	—
Low Temperature Operation	Endurance test applying the electric stress under low temperature for a long time.	-20°C 200hrs	1
High Temperature/ Humidity Operation	The module should be allowed to stand at 60°C,90%RH max	60°C,90%RH 96hrs	1,2
Thermal shock resistance	<p>The sample should be allowed stand the following 10 cycles of operation</p> <p style="text-align: center;">-20°C 25°C 70°C</p> <div style="text-align: center;">  </div>	-20°C/70°C 10 cycles	—
Vibration test	Endurance test applying the vibration during transportation and using.	Total fixed amplitude : 1.5mm Vibration Frequency : 10~55Hz One cycle 60 seconds to 3 directions of X,Y,Z for Each 15 minutes	3
Static electricity test	Endurance test applying the electric stress to the terminal.	VS=±600V(contact), ±800v(air), RS=330Ω CS=150pF 10 times	—

Note1: No dew condensation to be observed.

Note2: The function test shall be conducted after 4 hours storage at the normal Temperature and humidity after remove from the test chamber.

Note3: The packing have to including into the vibration testing.

5.7" TFT – 320x240 dots with PCAP

11. TOUCHPANEL INFORMATION

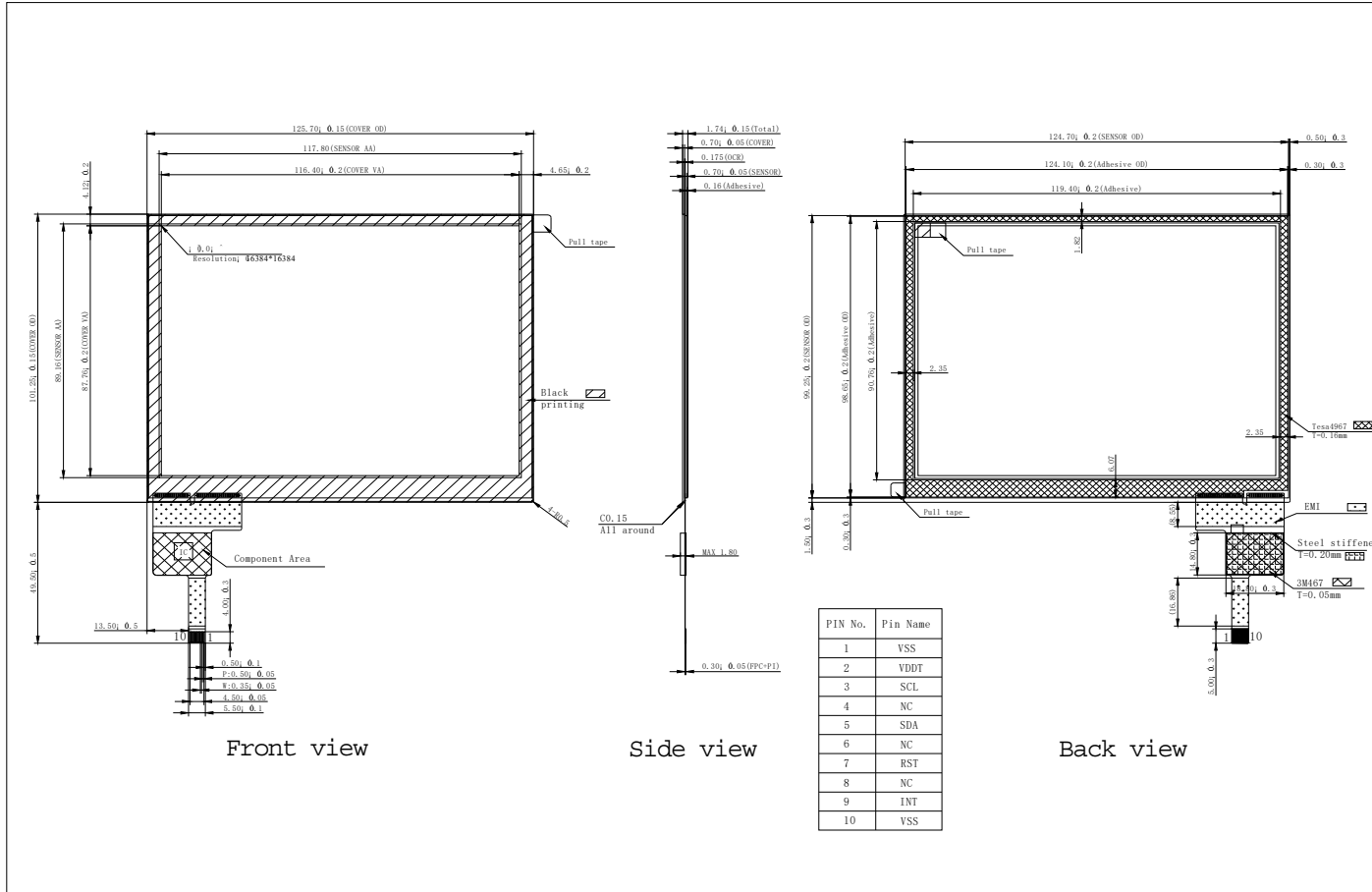

5.7" TFT – 320x240 dots with PCAP

11.1 PCAP CONTROLLER ILI2130

The device addresses are 7-binary bits long and are conventionally expressed as 4 bits followed by 3 bits followed by the letter 'b', 1000 001b. These addresses occupy the high seven bits of an eight-bit field on the bus.

MSB							LSB
1	0	0	0	0	0	1	0/1
7-bit Device Address							R/W

7-bit Device Address: 0x41

8-bit Device Address Read: 0x83

8-bit Device Address Write :0x82

11.2 I²C AC CHARACTERISTICS

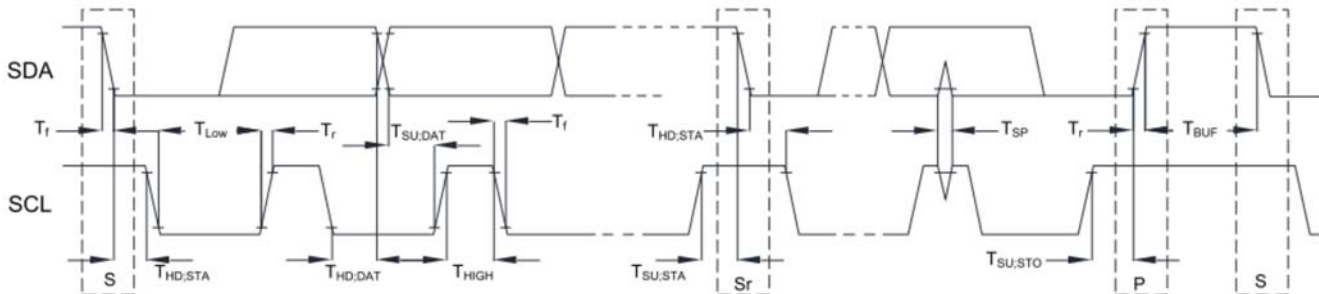

Item	Symbol	100kHz		400kHz		Unit
		Min.	Max.	Min.	Max.	
SCL standard mode clock frequency	F _{SCL}	0	100	0	400	kHz
Hold time (repeated) START condition. After this period, the first clock is generated.	T _{HD;STA}	4	--	0.6	--	us
LOW period of the SCL clock	T _{LOW}	4.7	--	1.3	--	us
HIGH period of the SCL clock	T _{HIGH}	4	--	0.6	--	us
Setup time for a repeat START condition.	T _{SU;STA}	4.7	--	0.6	--	us
Data hold time	T _{HD;DAT}	0	3.45	0	0.9	us
Data setup time	T _{SU;DAT}	250	--	100	--	ns
Rising time of both SDA and SCL signals	T _r	--	1000	--	300	ns
Falling time of both SDA and SCL signals	T _f	--	300	--	300	ns
Setup time for STOP condition.	T _{SU;STO}	4	--	0.6	--	us
Free time between STOP and START condition	T _{BUF}	4.7	--	1.3	--	us
Pulse width of spikes which must be suppressed by input filter	T _{SP}	--	--	0	50	ns

11.3 POWER ON SEQUENCE

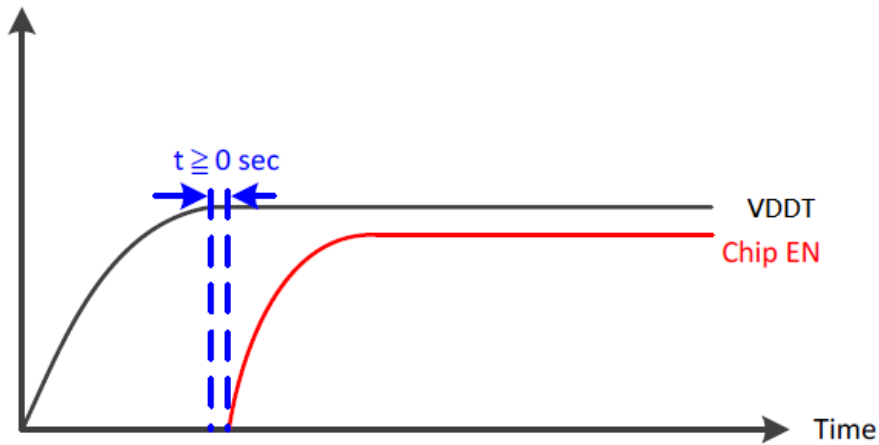

11.4 POWER OFF TO ON SEQUENCE

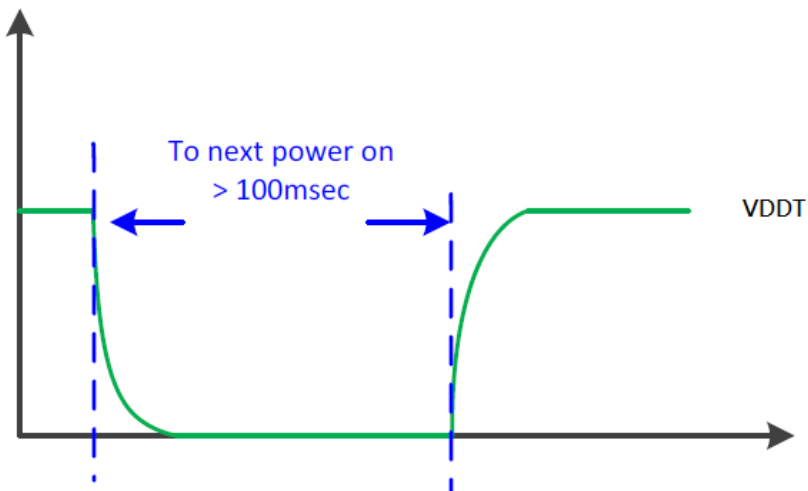

11.5 CODE EXAMPLE FOR PCAP

```

#include "main.h"
//===== By IC =====
unsigned char ILI2130_buf[11];
/*****
 * if touch point add 3~10 finger
 * u can add buf size for add finegr
 * 1 finger point add bufsize[5]
 * finger 1 buf[2~5]
 * finger 2 buf[7~10]
 * finger 3 buf[12~15]
 * finger 4 buf[17~20]
 * finger 5 buf[22~25]
 * finger 6 buf[27~30]
 * finger 7 buf[32~35]
 * finger 8 buf[37~40]
 * finger 9 buf[42~45]
 * finger 10 buf[47~50]
 * 10 finger total 51 buf
 *****/

void CTP_initial_ILI2130(void)
{
    TRISCBits.TRISC4 = 0; //CTP_SCL
    TRISGBits.TRISG7 = 0; //CTP_SDA
    TRISABits.TRISA2 = 1; //CTP_INT
    CNPU3bits.CN35PUE = 1; //INT_Internal Pull High
}

void I2C_SrCondition(void)
{
    CTP_SCL = 0;
    delay(T4);
    CTP_SDA = 1;
    delay(T4);

    CTP_SCL = 1;
    delay(T4);
    CTP_SDA = 0;
    delay(T4);
}

void I2C_CLK_ILI2130(void)// I2C_SCL Timing
{
    CTP_SCL = 1; //SCL High
    delay(T4); //delay(4)

    CTP_SCL = 0; //SCL Low
    delay(T4); //delay(4)
}
//=====
unsigned char ILI2130_DataRead(void)
{
    unsigned char Data;

    Data = LCD_GetData_I2C();

    return Data ;
}

```



```
//=====
void ILI2130_received_data(void)
{
    unsigned int i;

    //TOUCH DATA
    for(i=0;i<11;i++)
    {
        ILI2130_buf[i]=ILI2130_DataRead();
        CTP_SDA = 0;
        delay(T4);
        I2C_CLK_ILI2130();
    }
    I2C_StopCondition();
}

//=====
unsigned int ILI2130_Get_X1_Value_16bit(void)
{
    unsigned int temp,temp1;

    temp=0;
    if(ILI2130_buf[1]==0x40)
    {
        temp|=ILI2130_buf[3];
        temp1=(temp<<8);
        temp= temp1|ILI2130_buf[2];
    }
    return temp;
}

unsigned int ILI2130_Get_Y1_Value_16bit(void)
{
    unsigned int temp2,temp3;

    temp2=0;
    if(ILI2130_buf[1]==0x40)
    {
        temp2|=ILI2130_buf[5];
        temp3=(temp2<<8);
        temp2= temp3|ILI2130_buf[4];
    }
    return temp2;
}

unsigned int ILI2130_Get_X2_Value_16bit(void)
{
    unsigned int temp,temp1;
    temp=0;
    if(ILI2130_buf[6]==0x41)
    {
        temp|=ILI2130_buf[8];
        temp1=(temp<<8);
        temp= temp1|ILI2130_buf[7];
    }
    return temp;
}

unsigned int ILI2130_Get_Y2_Value_16bit(void)
{
    unsigned int temp2,temp3;

    temp2=0;
    if(ILI2130_buf[6]==0x41)
    {
        temp2|=ILI2130_buf[10];
        temp3=(temp2<<8);
        temp2= temp3|ILI2130_buf[9];
    }
}
```

```
    return temp2;
}

void ILI2130_Communication(void)
{
    I2C_StartCondition();           //s
    LCD_SendAddress(0x82);         //A           write to slave 8
    Slave_ack(); //1

    LCD_SendAddress(0x10); //8
    Slave_ack(); //1
    //I2C_StopCondition();

    I2C_SrCondition();
    LCD_SendAddress(0x83);         //   read slave data
    Slave_ack();
}
//=====
```

11.6 PROGRAMMING GUIDE FOR PCAP

More information on getting touch data and programming is written here:

https://www.lcd-module.de/eng/pdf/zubehoer/ILI2130_Programming_Guide_V1_50.pdf

11.7 COMPARSION BETWEEN ILI2130 AND FT5426 (EA TFT057-84ATS)

https://www.lcd-module.de/eng/pdf/zubehoer/ILI2130_comparsion_FT5426.pdf

12. CONTOUR DRAWING

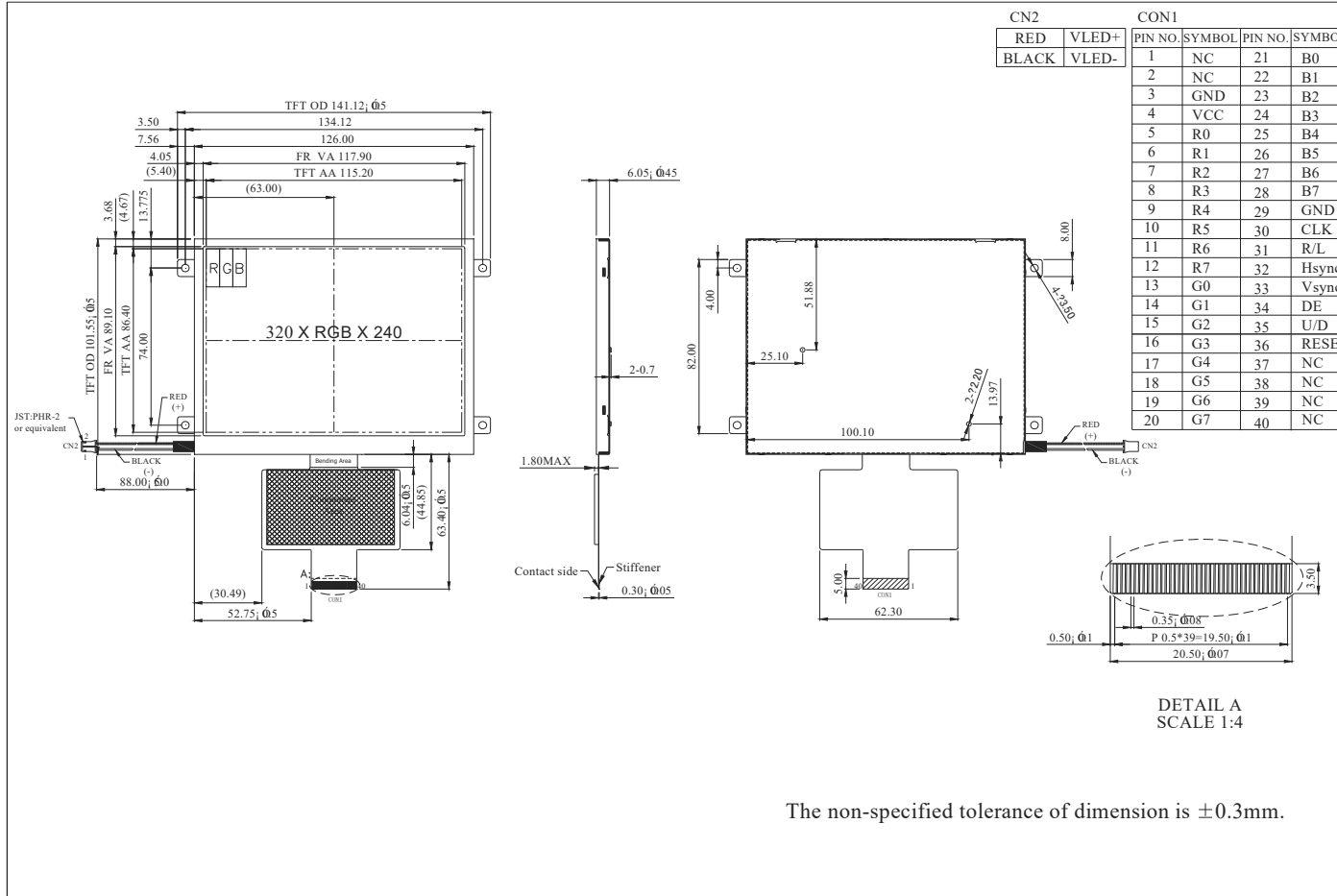

The non-specified tolerance of dimension is $\pm 0.3\text{mm}$.